

PROJECT	
TYPE	
NOTES	
QUANTITY	
DATE	

RING SUSPENSION

D81088

GENERAL

Series: Ring
 Brand: Panzeri
 Division: Design
 Mounting Type: Suspension
 Mounting Location: Ceiling
 Subcategory: Pendant

PHYSICAL

Shape: Sphere
 Diameter (mm): 250
 Diameter (in): 9 7/8
 Height (mm): 230
 Height (in): 9
 Max. Overall Height (mm): 2230
 Max. Overall Height (in): 87 13/16
 Light Distribution: Omnidirectional
 Weight (kg): 0.5
 Weight (lbs): 1
 Diffuser: Orange Blown Glass
 Fixture Finish: Chrome
 Fixture Material: Metal

ELECTRICAL

Number of Lamps: 1
 Lamp Type: LED Retrofit
 Lamp Shape: G25
 Bulb Included: Bulb Not Included
 Total Output Wattage (W): 9
 Max. Wattage Per Lamp (W): 9
 Lamp Base: E26
 Input Voltage (V): 120
 Upon Request: 277Vac / GU24

LED

OPTICAL

RATINGS AND CERTIFICATIONS

Certified By: CSA Certified to UL and CSA Standards
 IP rating: IP20

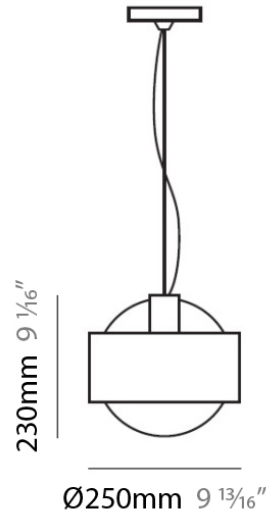

PROJECT	
TYPE	
NOTES	
QUANTITY	
DATE	

RING SUSPENSION

D81090

GENERAL

Series: Ring
 Brand: Panzeri
 Division: Design
 Mounting Type: Suspension
 Mounting Location: Ceiling
 Subcategory: Pendant

PHYSICAL

Shape: Sphere
 Diameter (mm): 390
 Diameter (in): 15 1/4
 Height (mm): 360
 Height (in): 14 1/4
 Max. Overall Height (mm): 2360
 Max. Overall Height (in): 92 15/16
 Light Distribution: Omnidirectional
 Weight (kg): 0.5
 Weight (lbs): 1
 Diffuser: White Blown Glass
 Fixture Finish: Chrome
 Fixture Material: Metal

ELECTRICAL

Number of Lamps: 1
 Lamp Type: LED Retrofit
 Lamp Shape: G30
 Bulb Included: Bulb Not Included
 Total Output Wattage (W): 12
 Max. Wattage Per Lamp (W): 12
 Lamp Base: E26
 Input Voltage (V): 120
 Upon Request: 277Vac / GU24

LED

OPTICAL

RATINGS AND CERTIFICATIONS

Certified By: CSA Certified to UL and CSA Standards
 IP rating: IP20

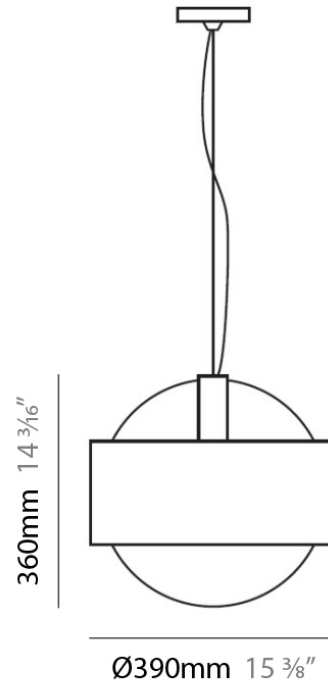

PROJECT	
TYPE	
NOTES	
QUANTITY	
DATE	

RING SUSPENSION

D81164

GENERAL

Series: Ring
 Brand: Panzeri
 Division: Design
 Mounting Type: Suspension
 Mounting Location: Ceiling
 Subcategory: Pendant

PHYSICAL

Shape: Sphere
 Diameter (mm): 145
 Diameter (in): 5 3/4
 Height (mm): 250
 Height (in): 9 7/8
 Max. Overall Height (mm): 2250
 Max. Overall Height (in): 88 9/16
 Light Distribution: Omnidirectional
 Weight (kg): 2.3
 Weight (lbs): 5
 Diffuser: White Glass
 Fixture Finish: Chrome
 Fixture Material: Metal

ELECTRICAL

Number of Lamps: 1
 Lamp Type: LED Retrofit
 Lamp Shape: T4
 Bulb Included: Bulb Not Included
 Total Output Wattage (W): 3
 Max. Wattage Per Lamp (W): 3
 Lamp Base: G9
 Input Voltage (V): 120

LED

OPTICAL

RATINGS AND CERTIFICATIONS

Certified By: CSA Certified to UL and CSA Standards
 IP rating: IP20

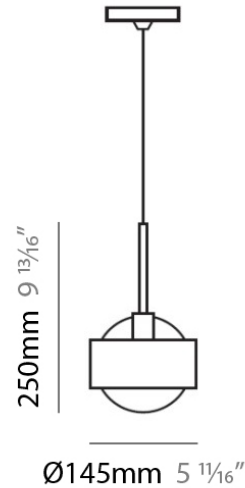

RING SUSPENSION

D81169

GENERAL

Series: Ring
Brand: Panzeri
Division: Design
Mounting Type: Suspension
Mounting Location: Ceiling
Subcategory: Pendant

PHYSICAL

Shape: Sphere
Diameter (mm): 145
Diameter (in): 5 3/4
Height (mm): 250
Height (in): 9 7/8
Max. Overall Height (mm): 2250
Max. Overall Height (in): 88 9/16
Light Distribution: Omnidirectional
Weight (kg): 2.3
Weight (lbs): 5
Diffuser: White Glass
Fixture Finish: Chrome
Fixture Material: Metal

ELECTRICAL

Number of Lamps: 1
Lamp Type: LED Retrofit
Lamp Shape: T4
Bulb Included: Bulb Not Included
Total Output Wattage (W): 3
Max. Wattage Per Lamp (W): 3
Lamp Base: G9
Input Voltage (V): 120

LED

OPTICAL

RATINGS AND CERTIFICATIONS

Certified By: CSA Certified to UL and CSA Standards
IP rating: IP20

PROJECT

TYPE

NOTES

QUANTITY

DATE

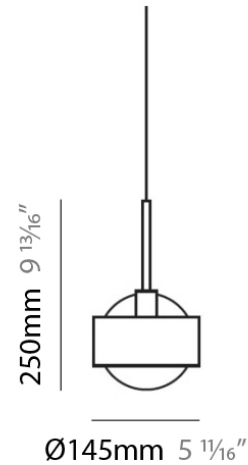

RING SUSPENSION

D81176

GENERAL

Series: Ring
Brand: Panzeri
Division: Design
Mounting Type: Suspension
Mounting Location: Ceiling
Subcategory: Pendant

PHYSICAL

Shape: Sphere
Diameter (mm): 250
Diameter (in): 9 7/8
Height (mm): 230
Height (in): 9
Light Distribution: Direct / Indirect
Weight (kg): 2.3
Weight (lbs): 5
Fixture Finish: Chrome
Fixture Material: Metal

ELECTRICAL

Number of Lamps: 1
Lamp Type: LED Retrofit
Lamp Shape: G25
Bulb Included: Bulb Not Included
Total Output Wattage (W): 9
Max. Wattage Per Lamp (W): 9
Lamp Base: E26
Input Voltage (V): 120
Upon Request: 277Vac / GU24

LED

OPTICAL

RATINGS AND CERTIFICATIONS

Certified By: CSA Certified to UL and CSA Standards
IP rating: IP20

PROJECT	_____
TYPE	_____
NOTES	_____
QUANTITY	_____
DATE	_____

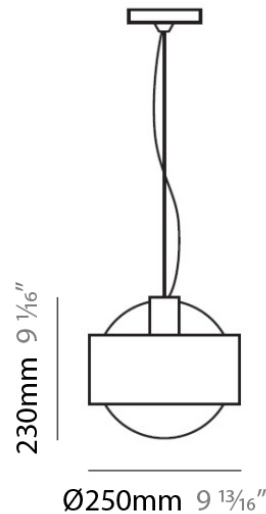

PROJECT
TYPE
NOTES
QUANTITY
DATE

RING SURFACE

D83132

GENERAL

Series: Ring
 Brand: Panzeri
 Division: Design
 Mounting Type: Surface
 Mounting Location: Wall
 Subcategory: Ambient

PHYSICAL

Shape: Sphere
 Length (mm): 155
 Length (in): 6 1/8
 Height (mm): 145
 Height (in): 5 3/4
 Extension (mm): 150
 Extension (in): 6
 Light Distribution: Omnidirectional
 Weight (kg): 3.6
 Weight (lbs): 8
 Diffuser: Black Glass
 Fixture Finish: Chrome
 Fixture Material: Metal

ELECTRICAL

Number of Lamps: 1
 Lamp Type: LED Retrofit
 Lamp Shape: T4
 Bulb Included: Bulb Not Included
 Total Output Wattage (W): 5
 Max. Wattage Per Lamp (W): 5
 Lamp Base: G9
 Input Voltage (V): 120

LED

OPTICAL

RATINGS AND CERTIFICATIONS

Certified By: CSA Certified to UL and CSA Standards
 IP rating: IP20

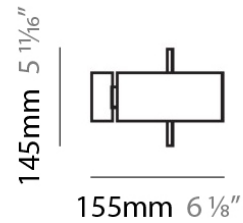

RING PORTABLE

D84102

GENERAL

Series: Ring
Brand: Panzeri
Division: Design
Mounting Type: Portable
Mounting Location: Floor
Subcategory: Floor

PHYSICAL

Shape: Sphere
Diameter (mm): 250
Diameter (in): 9 ⁷/₈
Height (mm): 1800
Height (in): 71
Light Distribution: Omnidirectional
Weight (kg): 0.5
Weight (lbs): 1
Diffuser: Black Blown Glass
Fixture Finish: Chrome
Fixture Material: Glass / Aluminum

ELECTRICAL

Number of Lamps: 1
Lamp Type: LED Retrofit
Lamp Shape: T10
Bulb Included: Bulb Not Included
Total Output Wattage (W): 24
Max. Wattage Per Lamp (W): 24
Lamp Base: E26
Input Voltage (V): 120

LED

OPTICAL

RATINGS AND CERTIFICATIONS

Certified By: CSA Certified to UL and CSA Standards
IP rating: IP20

PROJECT	_____
TYPE	_____
NOTES	_____
QUANTITY	_____
DATE	_____

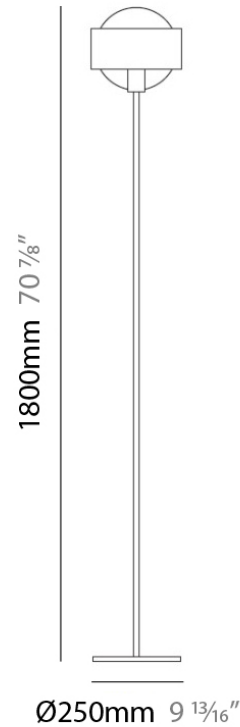

RING PORTABLE

D84244

GENERAL

Series: Ring
Brand: Panzeri
Division: Design
Mounting Type: Portable
Mounting Location: Table
Subcategory: Table

PHYSICAL

Shape: Sphere
Diameter (mm): 145
Diameter (in): 5 3/4
Height (mm): 155
Height (in): 6 1/8
Light Distribution: Omnidirectional
Weight (kg): 3.2
Weight (lbs): 7
Diffuser: White Glass
Fixture Finish: Chrome
Fixture Material: Glass / Aluminum

ELECTRICAL

Number of Lamps: 1
Lamp Type: LED Retrofit
Lamp Shape: T4
Bulb Included: Bulb Not Included
Total Output Wattage (W): 7
Max. Wattage Per Lamp (W): 7
Lamp Base: G9
Input Voltage (V): 120

LED

OPTICAL

RATINGS AND CERTIFICATIONS

Certified By: CSA Certified to UL and CSA Standards
IP rating: IP20

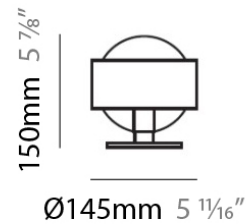

LEGEND

	floor-mounted		pivotal		special LED (upon request) RGB, RGBW, tunable, gold+, meat+, art+, fashion+
	wall and ceiling: recessed and surface mounted		rotating		warm dim / natural dimming LED
	ceiling-mounted and wall-mounted		illuminate tilted		rechargeable battery powered
	wall-mounted		color of suspension cable		fixture with natural vivid LED (upon request)
	omni-directional light distribution		length of suspension cable		color rendering index
	direct light distribution		reflector degree selection		color temperature
	direct/indirect light distribution		super spot		lumen (luminous flux)
	indirect light distribution		lens		efficacy (lumens per watt)
	asymmetric light distribution		lens pack		Unified Glare Rating (UGR) range from 5-40
	aura light distribution		shine ring		marine grade (AISI 316 stainless steel)
	round wall or ceiling cut-out		integrated shine ring with diffuser		walk on
	square wall or ceiling cut-out		free individual colors 01-29		drive on
	the supplied jig specifies the cutout dimensions		individual colors: 00 (free of charge), 01-25 (extra charge)		Dark Sky Compliance
	minimum distance (meters) lamp - object		luminaire part to be colored (F1)		Americans with Disabilities Act (less than 4" off the wall located between 27"-84" from floor)
	recessed depth		luminaire part to be colored (F2)		lamp protected against explosion
	ceiling thickness in mm		luminaire part to be colored (F3)		blown glass using traditional methods by master glass blower
	ceiling thickness selection		luminaire part to be colored (F4)		acoustic material
	dimmable DP (phase), DV (0-10V), DD (dali), DS (step-dim)		luminaire part to be colored (F5)		protection class I, protection insulation
	included or excluded LED driver/transformer/control gear		color of 3-circuit adaptor		protection class II, protection insulation
	separately switchable		indirect diffuser		ETL Certified to UL and CSA Standards
	sensor		direct diffuser		UL Certified to UL and CSA Standards
	remote control		ball-proof (upon request)		CSA Certified to UL and CSA Standards
	available upon request		accessory		Certified for North American Standards

IP RATING

	protected against ingress of solid bodies greater than 12.5mm (finger)
	protected against ingress of solid bodies greater than 2.5mm protected against sprays of water up to 60 degrees from the vertical (rain)
	protected against ingress of solid bodies greater than 1mm (wire) no protection against the ingress of moisture
	protected against ingress of solid bodies greater than 1mm (wire) protected against sprays of water up to 60 degrees from the vertical (rain)
	protected against ingress of solid bodies greater than 1mm (wire) protected against water splashed from all directions
	protected against limited ingress of dust (wet rooms/covered outdoor areas) protected against water splashed from all directions
	protected against ingress of dust protected against jets of water
	protected against ingress of dust protected against powerful jets of water or heavy seas
	protected against ingress of dust protected against immersion of water between 15cm - 1m for 30 minutes
	protected against ingress of dust protected against immersion of water under pressure for long periods

IK RATING

	protected against 0.14 joules impact (equivalent to 0.25kg mass dropped from 56mm above the surface)
	protected against 0.2 joules impact (equivalent to 0.25kg mass dropped from 80mm above the surface)
	protected against 0.35 joules impact (equivalent to 0.25kg mass dropped from 140mm above the surface)
	protected against 0.5 joules impact (equivalent to 0.25kg mass dropped from 200mm above the surface)
	protected against 0.7 joules impact (equivalent to 0.25kg mass dropped from 280mm above the surface)
	protected against 1 joules impact (equivalent to 0.25kg mass dropped from 400mm above the surface)
	protected against 2 joules impact (equivalent to 0.5kg mass dropped from 400mm above the surface)
	protected against 5 joules impact (equivalent to 1.7kg mass dropped from 300mm above the surface)
	protected against 10 joules impact (equivalent to 5.0kg mass dropped from 200mm above the surface)
	protected against 20 joules impact (equivalent to 5.0kg mass dropped from 400mm above the surface)